



Sink Bernini 36" x 21" – U/M - (USA)

Kitchen Sinks

Code: 3780 660

AISI 304 Stainless steel

Satin finish

Undermount

x cross bending for easy water draining



DETAILS

Edge/Installation Type	Undermount
Series	Bernini
Finish	Satin finish
Material	AISI 304 stainless steel
Thickness	16 Gauge (1.5 mm)
Overall dimensions	37 ³¹ / ₆₄ " x 22 ³¹ / ₆₄ "
Bowls dimensions	1 bowl 36" x 15 ³ / ₄ "
Bowls depth	10 "

Cut out	36" x 21"
Waste fitting type	3 1/2" - with stainless steel basket
Bowls bottom	X cross bending for easy water draining
Fixing system	Undermount fixing kit (brass insert and clips)
Underside	Protected with heavy duty undercoating

FEATURES

Diamond-shape bottom	The draining of water is an important feature in a sink, and it's always taken good care of in Foster products. In the bent-welded sinks, which would have a flat bottom, the proper draining is guaranteed by the elegant beveling, which helps the water flow.
High thickness	1.5 mm thick steel. A significant thickness, which guarantees the maximum sturdiness and durability.
Basket 3,5" waste fitting	The drain is equipped with a large 3.5" drain, with the practical basket cap that prevents the discharge of solid parts.

TECHNICAL DATA

3780 660

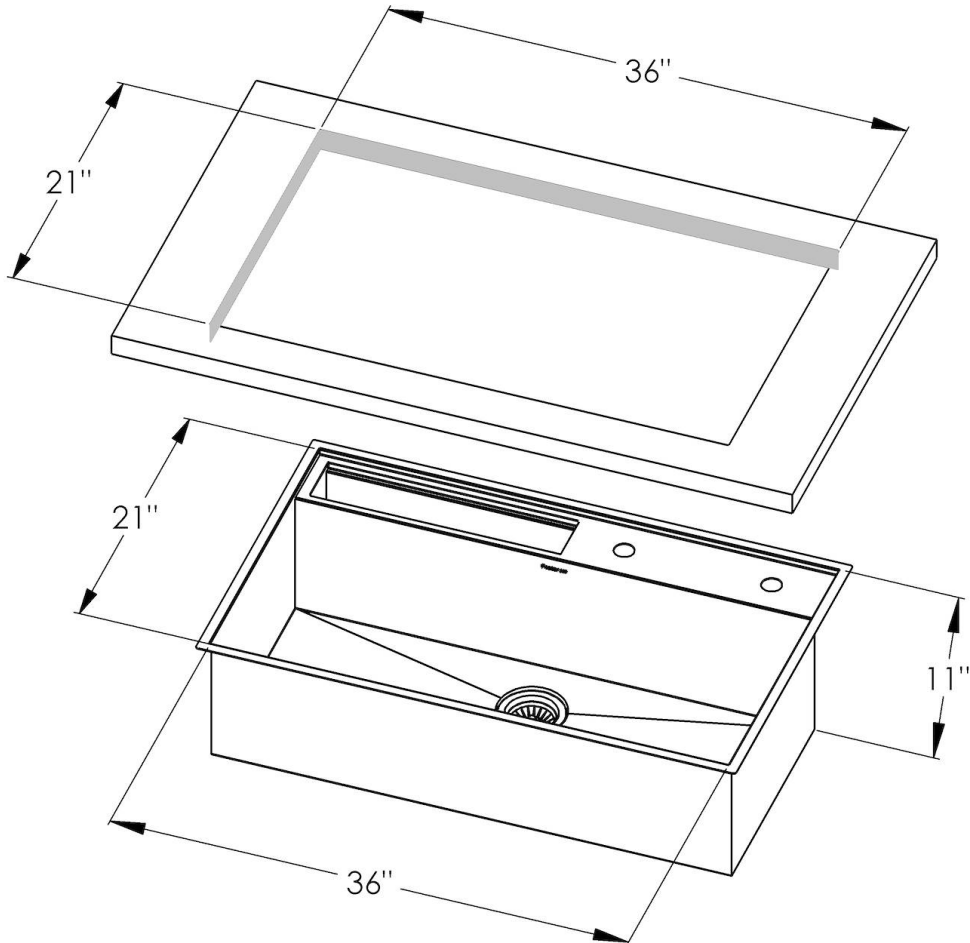

Edge positioning

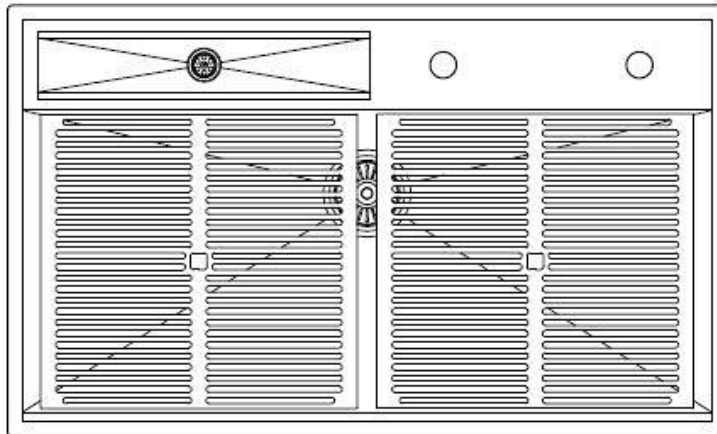
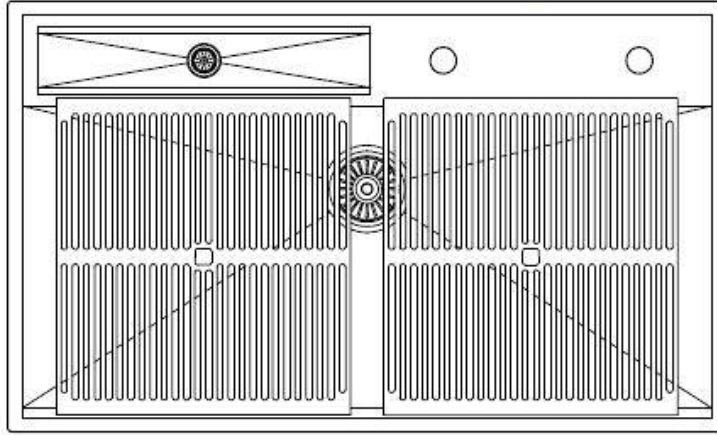

Bottom positioning

Bernini Optional accessories

The "rails" system makes it possible to use a combination of numerous accessories. Grids, chopping boards, utensils' ranging system, bowls and containers of different dimensions can be alternated in the workspace with a simple gesture, and can easily be stacked, in order to be on hand at all times.

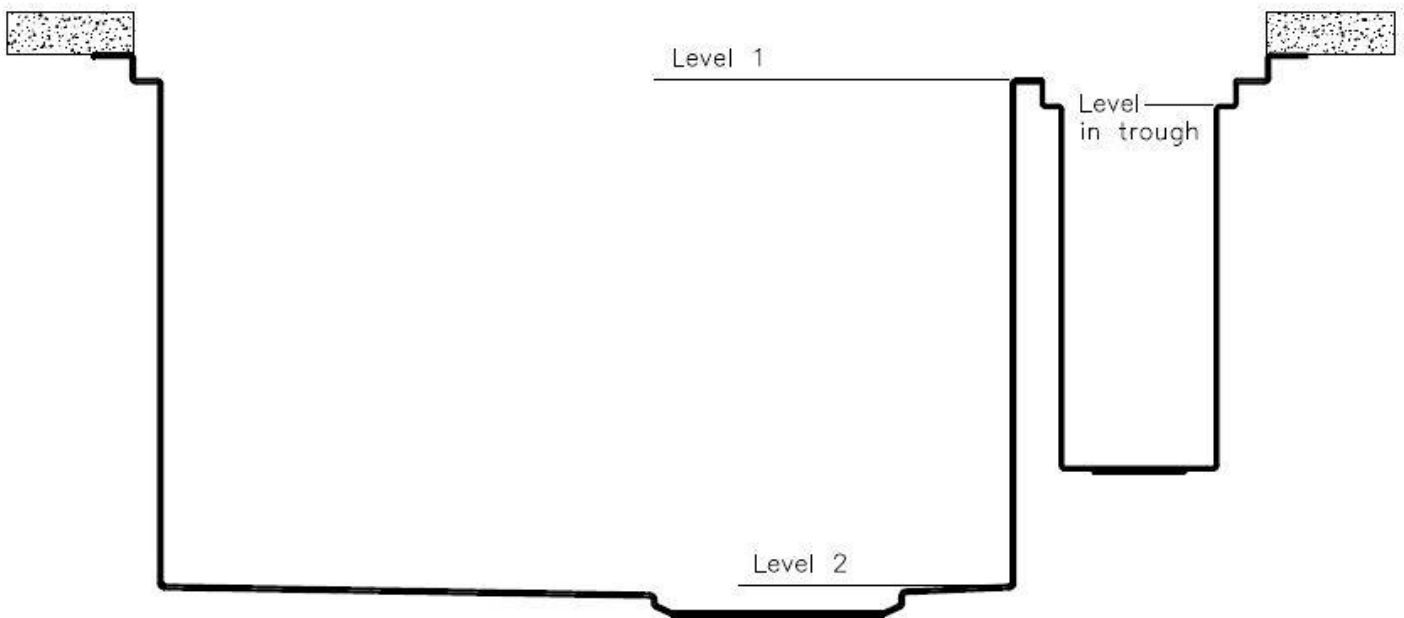

Bernini Level 1

Compatible accessories:

8100 617

8200 002

8644 044

8100 201

8153 100

8657 001

8657 002

8631 300

8644 101

8151 000 (only to be matched with 8644 101)

8159 101 (only to be matched with 8644 101)

8100 303 (only to be matched with 8644 101)

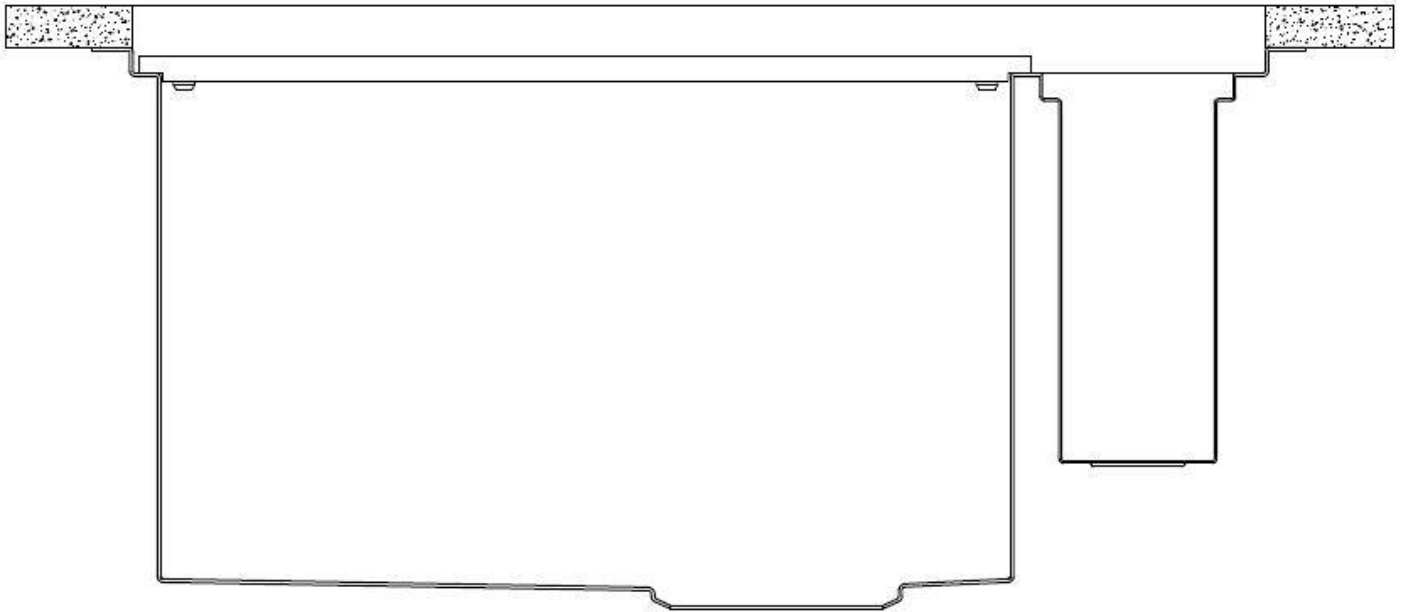

Bernini Level 2

Compatible accessories:

8100 617

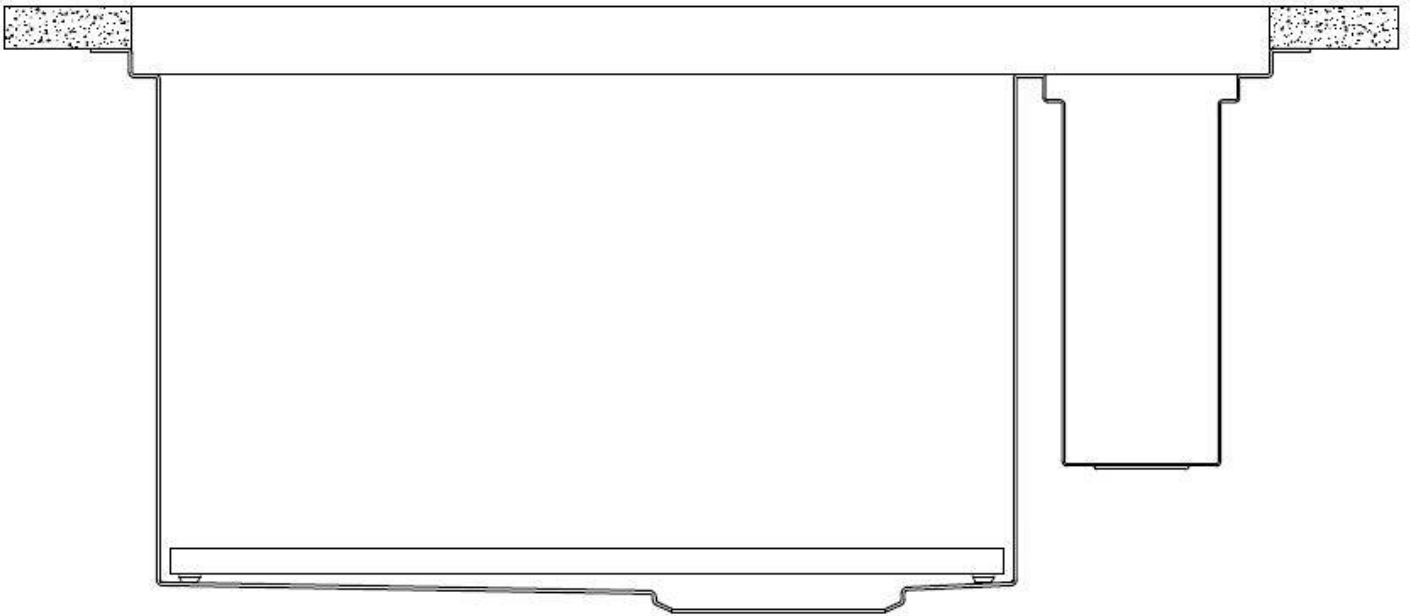

Bernini Level "in trough"

Compatible accessories:

8100 709

Kit con vaschetta

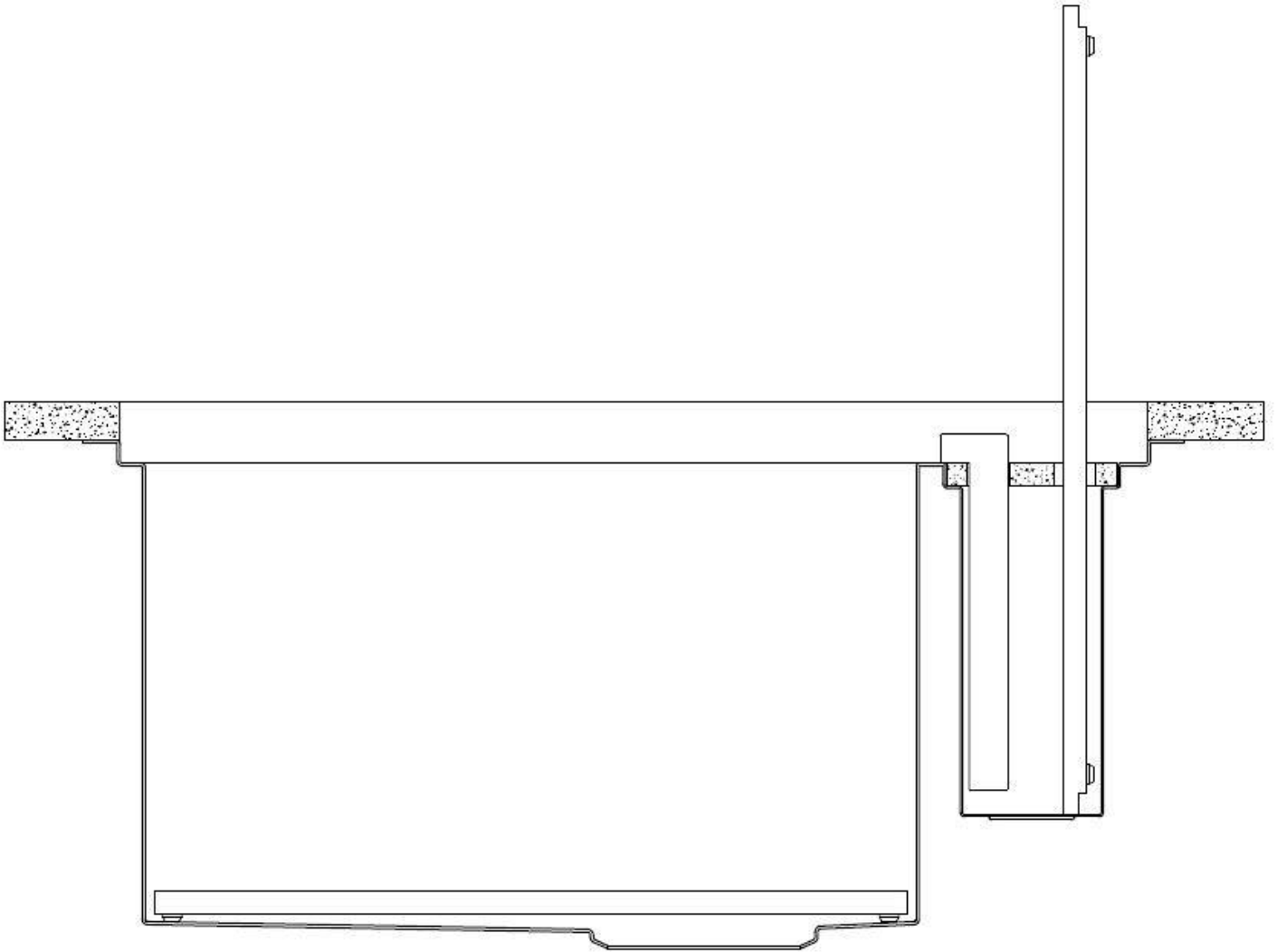

GALLERY

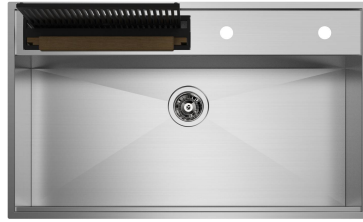
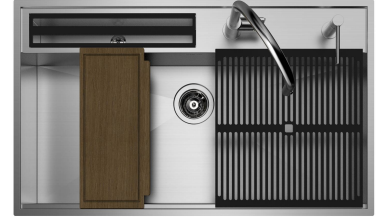

EQUIPMENT



Black grid
8100 617



Kit Black support frame + Iroko wood chopping board
8100 709

OPTIONAL ACCESSORIES



Steel colander (cutlery holder + Black support)
8100 006



Bamboo chopping board
8200 002



Black grid
8100 617



Grating kit complete with ring support and food collection tray

8159 101

* only in combination with the accessory
8644 101



Iroko-wood sliding chopping board with stainless steel colander

8644 044

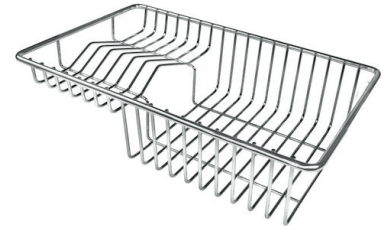

Stainless Steel dishes holder

8100 303

* only in combination with the accessory
8644 101



Stainless steel perforated pan

8151 000

* only in combination with the accessory
8644 101



Stainless steel plate rack

8100 201



Waste disposer throat

8669 043



White bowl

8153 100



Twin Chopping Board

8644 101



Chopping Board

8631 300

RECOMMENDED PAIRINGS



Dispenser Evo polished
8520 010



Faucet Stromboli
8471 005



Faucet Capri
8467 005



Faucet Salina
8487 005



Milano Cooktop 5 burners
7638 900